



products with a watertight reputation

AQ-DM-5UBT - DIGITAL MEDIA LOCKER™

for Bluetooth, USB, iPhone, iPod, MP3 devices and FM Radio

OWNERS MANUAL



! PLEASE READ THIS INSTRUCTION MANUAL BEFORE INSTALLATION AND OPERATION !

| | |
|--|-----------|
| 1 Getting Started | 3 |
| 1.1 Contents..... | 3 |
| 1.2 Connections..... | 3 |
| 1.3 12-pin Harness Connection..... | 4 |
| 1.4 Mounting the Digital Media Locker..... | 4 |
| 1.5 Remote Control Battery Install..... | 5 |
| 1.6 Power On..... | 5 |
| 1.7 Remote Control Synchronizing..... | 5 |
| 2 Location of Controls | 6 |
| 2.1 Digital Media Locker Controls..... | 6 |
| 2.2 Door Keypad Controls..... | 7 |
| 2.3 Remote Control..... | 8 |
| 3 Listening to Devices | 9 |
| 3.1 Listening via USB..... | 9 |
| 3.1.1 Navi Search..... | 9 |
| 3.1.1.1 USB Search..... | 9 |
| 3.1.1.2 iPhone & iPod Search..... | 9 |
| 3.1.2 Device Charging..... | 9 |
| 3.1.3 iPhone & iPod Compatible Models..... | 10 |
| 3.2 Listening via Bluetooth..... | 10 |
| 3.2.1 Pair with Bluetooth Device..... | 10 |
| 3.2.2 Listening via Bluetooth Device..... | 10 |
| 3.3 Listening via Auxiliary Input..... | 10 |
| 3.4 Adjust Volume Level..... | 10 |
| 4 Listening to FM Radio | 11 |
| 4.1 Enter FM Radio Mode..... | 11 |
| 4.2 Scan or Seek FM Radio Channels..... | 11 |
| 4.3 Saving Radio Channel to Memory..... | 11 |
| 4.4 Listening to Saved Radio Memory..... | 11 |
| 4.5 Switch between US and European FM Modes..... | 11 |
| 4.6 Adjust Volume Level..... | 11 |
| 5 Additional Features | 12 |
| 5.1 External 12V Trigger..... | 12 |
| 5.2 Internal Dock Light..... | 12 |
| 6 Specifications & Dimensions | 13 |
| 6.1 Specifications..... | 13 |
| 6.2 Dimensions..... | 13 |
| 7 Warranty Information | 14 |

1.1 Contents

- AQ-DM-5UBT Digital Media Locker™
- 2-Way RF Waterproof Remote Control (AQ-RFDM-5UBT)
- Jack Cable (3.5mm Male to 3.5mm Male)
- Wiring Harness (AQ-UNH-2)
- Six (6) Stainless Steel Mounting Screws
- One (1) CR-2430 Battery
- Mounting Template
- Owner's Manual

1.2 Connections

1. 12-pin Watertight Harness

The 12-pin harness supplies power and ground connections to the Digital Media Locker and four (4) speaker channel output connections from the Digital Media Locker.

 *Do not cut or modify the 12-pin harness on the Locker side or warranty will be void.*

2. FM Radio Antenna Jack

Connect antenna (AQ-ANT-1 sold separately) to female antenna receptacle. For best FM performance make sure the antenna is extended to the highest achievable position.

3. Auxiliary Outputs

Allows external amplifiers to be connected to power additional speakers.

4. Auxiliary Inputs

Allows input of external audio signal from RCA connectors.

5. 12V DC External Trigger

Allows for an external light or relay to be triggered (350mA max load).

6. Backlighting 12V DC Input

Connects to the 12VDC External Trigger to provide power for the Digital Media Locker's internal LED illumination. By default this wire is connected to the 12V DC External Trigger wire.

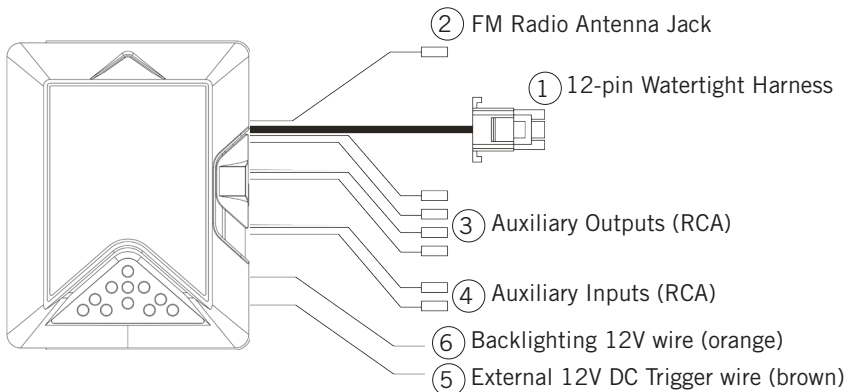

1.3 12-pin Harness Connection

The AQ-DM-5UBT includes the universal harness AQ-UNH-2 in order to connect the dock to power and speakers.

All open wire connections should be soldered and protected against water and dust for best long term performance.

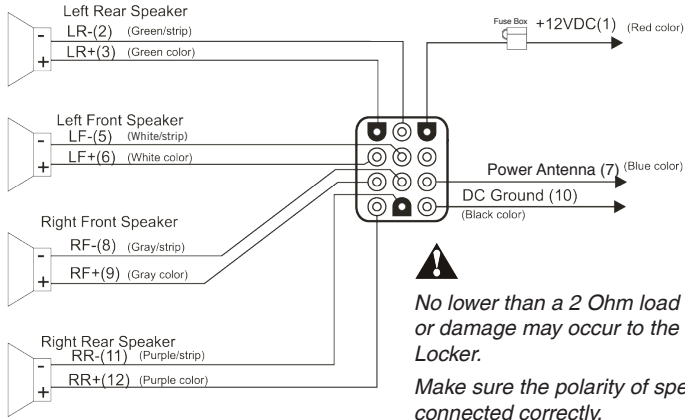

1.4 Mounting the Digital Media Locker

1. A mounting template is included. Aquatic AV recommends using the 'measure twice, cut once' method!
2. Once the mounting hole is complete, make sure the outside surface is clean and clear of debris. The Digital Media Locker has an external water/dust proof gasket, but this requires a clean and flat surface for best performance.
3. The Digital Media Locker has six (6) front screws. Drive the screws using a screw driver. During final mounting apply equal pressure to all points for the best water/dust outer seal performance. Make sure screws are snug and do not over tighten.
4. Review all outside surfaces of the Digital Media Locker to ensure proper water/dust seal. This is important for long term environmental protection performance for your digital media device.

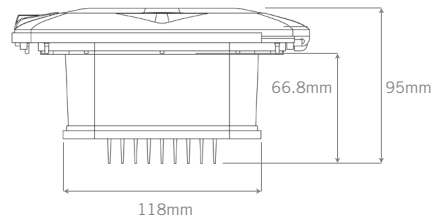
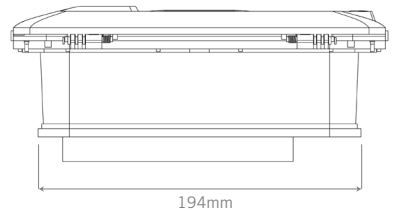

1.5 Remote Control Battery Install

Remove the RF wireless remote control from the Digital Media Locker box. Unscrew the water-proof cap on the back of the remote control. Place the CR-2430 battery in the RF remote control and replace the water/dust proof cap.

When the battery is installed, the remote control LCD should be solid and bright without any flickering.

1.6 Power On

Press the  on/off button.



Red Light: Power to the docking station is ON, but the unit is in standby mode.

Blue Light: The unit is powered ON and looking for an audio source.

For applications that require low current draw and where battery drain may occur, the power button must be turned OFF inside the unit. When the power button is in the OFF position the red LED will not be lit.

For applications where a 12V battery is not used, such as in a Spa, the power button can be left ON and the remote control or door controls can then be used to power on/off accordingly.

1.7 Remote Control Synchronizing

1. Turn the Digital Media Locker to off mode with the power button inside the door. The LED should not be illuminated.
2. Press the red  (POWER) button on the remote.
3. Press and hold the  (MODE) button until the LCD reads PAIR.
4. Continue to press and hold the  (MODE) button during step 5 below.
5. Turn the docking station to standby mode (within 10 seconds) with the on/off button inside door (the red LED will illuminate and then turn blue).
6. The remote's LCD should read WELCOME or show a mode position such as RADIO, USB, BT or AUX IN.

For any additional remote controls, you will also need to activate/synchronize those remote controls by following the steps above.

 *If the pairing process is not effective, switch the locker off using the on/off button located inside the door of the dock. Unplug the 12-pin Harness on the back of the Locker for 3 minutes. Reattach the Harness and repeat steps 1-6 above.*

 *If the pairing process is not effective, check the battery voltage. If above 3V DC refer to section 1.5 above to make sure the battery is installed correctly. If battery voltage is below 3V DC replace the battery.*

 *If the LCD displays "NO LINK" in either mode, this means the remote is out of reception range. Move the remote closer to the Locker and try again.*

 *If you lose your remote control and buy another new remote control, please follow the above to start pairing before normal usage.*

2.1 Digital Media Locker Controls

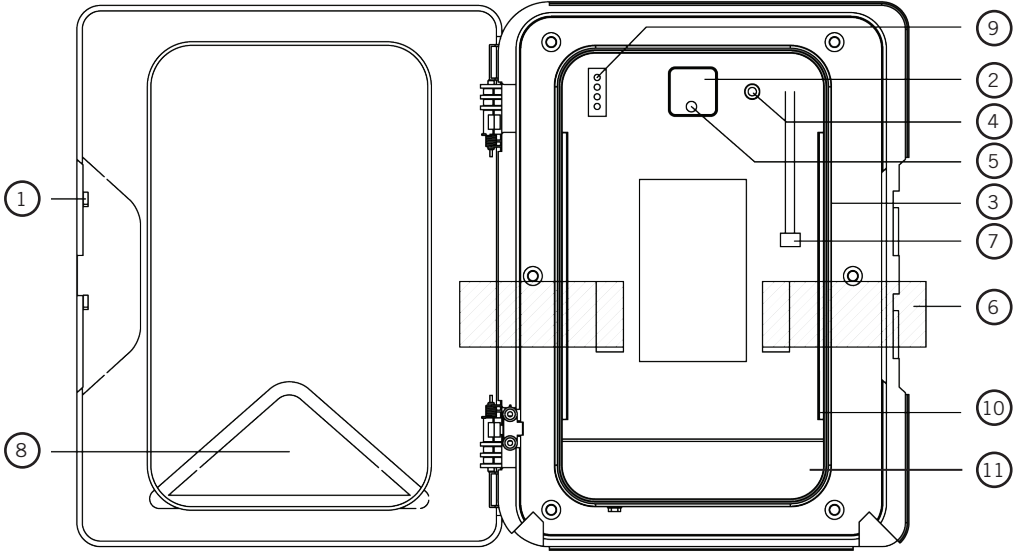

1. Open/Close Latch & Protective Door
2. Power ON/OFF Button
3. Water/Dust Protection Inner Gasket
4. 3.5mm Aux Input for MP3 Devices
5. Power ON/OFF LED

6. Security Strap for digital media devices
7. USB Connector
8. Door Control Keypad
9. LED Mode Indicator
10. Back lighting
11. Cable Storage Tray

2.2 Door Keypad Controls

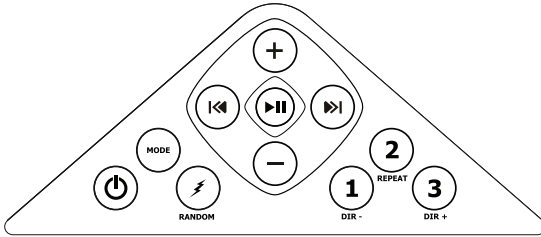







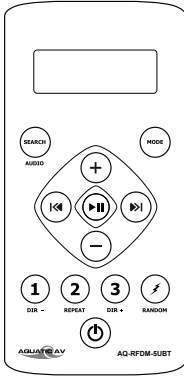





| Buttons | | Music Mode: iPhone, iPod, Bluetooth, USB & MP3 | FM Radio Mode |
|----------------------|--|---|--|
| Power | | Press once: Toggle from Operation mode to Standby mode or vice-versa. | |
| Mode | | Press once: Change the source. Press and hold: No function | Press once: Change the source. Press and hold: No function |
| Volume Up | | Press once: Volume up Press and hold: Fast volume up | Press once: Volume up Press and hold: Fast volume up |
| Volume Down | | Press once: Volume down Press and hold: Fast volume down | Press once: Volume down Press and hold: Fast volume down |
| Fast Rewind | | Press once: Previous track Press and hold: Fast rewind | Press once: Scan down Press and hold: Toggle manual seeking |
| Fast Forward | | Press once: Next track Press and hold: Fast forward | Press once: Scan up Press and hold: Toggle to manual seeking |
| 12V Trigger / Random | | Press once: Random playback Press and hold: Toggle 12V on/off | Press once: No function Press and hold: Toggle external 12V power on/off |
| Play/pause | | Press once: Play/Pause Press and hold: No function | Press once: Toggle mute Press and hold: No function |
| 1 / DIR- | | Press once: Back to previous folder Press and hold: No function | Press once: Listen to FM preset station 1 Press and hold: Set preset FM station 1 |
| 2 / REPEAT | | Press once: Repeat function Press and hold: No function | Press once: Listen to FM preset station 2 Press and hold: Set preset FM station 2 |
| 3 / DIR+ | | Press once: Forward to next folder Press and hold: No function | Press once: Listen to FM preset station 3 Press and hold: Set preset FM station 3 |

i The keypad on the door has a set of keys fewer than those on the remote but has exactly the same functions correspondingly. This keypad allows you to operate the dock without the remote control.

2.3 Remote Control



| Buttons | Music Mode: iPhone, iPod, Bluetooth, USB & MP3 | FM Radio Mode |
|----------------------|--|--|
| Power |  Press Once: Turns remote control on. Press Twice: Toggle from Operation mode to Standby mode or vice-versa. | |
| Mode |  Press once: Change the source. Press and hold: No function | Press once: Change the source. Press and hold: No function |
| Search / Audio |  Press once: Search Press and hold: Audio Menu (BAS-TRE-BAL-FAD-EUR-DX-MONO-STEREO) | Press once: Audio Menu (BAS-TRE-BAL-FAD-EUR-DX-MONO-STEREO) Press and hold: Audio Menu (BAS-TRE-BAL-FAD-EUR-DX-MONO-STEREO) |
| Volume Up |  Press once: Volume up Press and hold: Fast volume up | Press once: Volume up Press and hold: Fast volume up |
| Volume Down |  Press once: Volume down Press and hold: Fast volume down | Press once: Volume down Press and hold: Fast volume down |
| Play / Pause |  Press once: Play/Pause Press and hold: No function | Press once: Toggle mute Press and hold: No function |
| Fast Rewind |  Press once: Previous track Press and hold: Fast rewind | Press once: Scan down Press and hold: Toggle manual seeking |
| Fast Forward |  Press once: Next track Press and hold: Fast forward | Press once: Scan up Press and hold: Toggle manual seeking |
| 1 / DIR - |  Press once: Back to previous folder Press and hold: No function | Press once: Listen to FM preset station 1 Press and hold: Set preset FM station 1 |
| 2 / Repeat |  Press once: Repeat playback function Press and hold: Repeat function | Press once: Listen to FM preset station 2 Press and hold: Set preset FM station 2 |
| 3 / DIR + |  Press once: Forward to next folder Press and hold: No function | Press once: Listen to FM preset station 3 Press and hold: Set preset FM station 3 |
| 12V Trigger / Random |  Press once: Random playback function Press and hold: Toggle external 12V power on/off | Press once: No function Press and hold: Toggle external 12V power on/off |



i If your music player is connected via the Auxiliary input you will not be able to control track or receive track information.

i In order to prolong remote battery life the LCD will shut off in 20 seconds if no other button is pressed. To turn remote back on press any key once and then press the command desired.

i Turn off DSP to access control of Bass and Treble

i When in Bluetooth mode Repeat and Random playback functions must be enabled via your media device and not from the remote control.







3.1 Listening via USB

1. Power up the Digital Media Locker
2. Attach your device to the USB cable inside the Digital Media Locker using the appropriate USB adaptor.
3. Secure the device with the anchor straps provided.
4. Secure the Digital Media Locker's protective door.
5. Press  (POWER) on the remote control or Power button on the locker to turn it ON.
6. Press  (MODE) on the remote control to select USB mode. Use the buttons as shown in the remote function chart.







 *Always ensure to connect and disconnect your media player with dry hands!*

3.1.1 Navi Search

3.1.1.1 USB Search

1. When using a USB device, press  (SEARCH) to enter the USB searching mode.
2. Use  and  (Volume UP/DOWN) to scroll through the folders on your USB device and to select a folder press the  (PLAY/PAUSE) button.
3. Use  and  (Volume UP/DOWN) to scroll through the songs in the folder and press  (PLAY/PAUSE) to play the desired song.

3.1.1.2 iPhone & iPod Search

1. When using an iPhone or iPod, press  (SEARCH) to enter iPod searching mode.
2. Once in searching mode the remote will display 'Playlist'. Continue to press  (SEARCH) to scroll through the search modes below:
1) Playlist 2) Artist 3) Album 4) Song 5) Genre 6) Composer 7) Audio Book
3. Press  (PLAY/PAUSE) To select the desired search mode.
4. Use  and  (Volume UP/DOWN) to scroll through your media in the selected search mode.
5. Once you find the desired media press  (PLAY/PAUSE) to make your selection. If your selection is a song it will begin to play, if you select a playlist, artist, album, genre, composer or audio book, the songs in the selected folder will be visible. Press  (PLAY/PAUSE) to play the desired song within the folder.

3.1.2 Device Charging

When specified USB devices are connected to the USB input the device battery will charge.

3.1.3 iPhone & iPod Compatible Models



iPhone 4S
16GB 32GB 64GB



iPhone 4
8GB 16GB 32GB



iPod touch
4th generation
8GB 16GB 32GB 64GB

3.2 Listening via Bluetooth

IAP Bluetooth connectivity allows device information, such as song, playlist and album titles, to be streamed wirelessly and viewable on the remote control.

3.2.1 Pair with Bluetooth Device

1. Switch on your Bluetooth device.
2. Select 'AQUATIC AV' from the list of available devices to pair (no password is needed).

i Only one Bluetooth device can be paired with the Digital Media Locker at any time.

3.2.2 Listening via Bluetooth Device

1. Bluetooth mode will be activated once a Bluetooth device is linked.
2. Play the song from device and the sound will play through the Digital Media Locker.
3. Press (PLAY/PAUSE) to play/pause the song.
4. Press / (FAST REWIND/FORWARD) buttons to play previous/next song file.
5. Track and volume can be controlled directly from your Bluetooth device, remote control or door controls.

3.3 Listening via Auxiliary Input

1. Power up the Digital Media Locker.
2. Connect your MP3 device to either the 3.5mm Jack input or RCA input
3. Secure the device with the anchor straps provided.
4. Secure the Digital Media Locker's protective door.
5. Press (MODE) on the remote control to select 'AUX IN' mode.

i Only one Auxiliary input (3.5mm Jack or RCA) can be used at any one time.

3.4 Adjust Volume Level

1. Press (VOLUME UP) once to increase the volume.
2. Press (VOLUME DOWN) once to reduce the volume.
3. Press and hold either or and the Digital Media Locker will increase or decrease audio volume continuously.





4.1 Enter FM Radio Mode

1. Press  (MODE) on remote control to switch to FM radio mode.

i If this is the first time you listen to FM radio, the default frequency will be 87.5MHz, as shown on the remote LCD.



i FM radio is only available when you are in the FM Radio mode.

4.2 Scan or Seek FM Radio Channels



1. Press  (FAST REWIND) or  (FAST FORWARD) to seek another station.
2. Press and hold either  (FAST REWIND) or  (FAST FORWARD) for manual tuning back or forward.

i After using Seek mode the unit will automatically switch back into Scan mode after 20 seconds.



4.3 Saving Radio Channel to Memory

To save the current frequency into memory, press and hold ,  or  for more than 2 seconds. The station will be stored into relevant button.

4.4 Listening to Saved Radio Memory

Press the ,  or  preset button once to listen to the station stored in that button.





4.5 Switch between US and European FM Modes

1. Make sure dock and remote are turned on and in 'RADIO' mode.
2. Press the AUDIO button 6 time in a row.
3. The remote will display 'AREA USA' or 'AREA EUR' depending on which tuning mode is currently selected.
4. Use the  and  buttons to switch between US or European modes.
5. Press  (PLAY/PAUSE) to select the desired tuning mode.
6. Once you switch modes it will default to the FM station stored in 'PRESET'.

i US mode will increase and decrease the FM frequency in steps of 0.1 MHz, e.g. 88.5, 88.6, 88.7 MHz. EUR mode will increase and decrease the FM frequency in steps of 0.05 MHz, e.g. 88.25, 88.30, 88.35 MHz.

i When in Seek mode and European FM tuning mode, all frequency steps will be visible.

4.6 Adjust Volume Level

1. Press  (VOLUME UP) once to increase the volume.
2. Press  (VOLUME DOWN) once to reduce the volume.
3. Press and hold either  or  and the Digital Media Locker will increase or decrease audio volume continuously.

5.1 External 12V Trigger

Aquatic AV understands the need for more flexible remote applications. With the Digital Media Locker Aquatic AV has provided an independent 12V 'accessory' trigger, activated from the RF wireless remote. This could activate any 12V based device like 12V lights or 12V motors.

In any operational mode, press the  (12V TRIGGER) key to activate. Press again to deactivate.

 *Aquatic AV strongly recommend you speak to our technical service staff or your local Aquatic AV dealer if you are considering using this feature.*

 *Load on External Trigger should not exceed 350mA.*

5.2 Internal Dock Light

The Digital Media Locker will by default have orange and brown wires connected. Use the trigger on the remote to toggle the internal illumination light ON/OFF.

6.1 Specifications

Media

Supported media.....IAP Bluetooth/USB/iPod/iPhone/MP3/FM
Supported media max. dimensions.....107 x 184mm (WxH)
Device charging.....via USB
Device control.....via Door Controls & RF Remote Control

Inputs

USB.....USB 2.0
Auxiliary.....1x 3.5mm Stereo Jack Socket, 1x Stereo pair RCA input

Outputs

Pre-Out.....2x Stereo pair RCA (4V)

FM Radio

FM pre-sets.....3
US/Euro frequencies.....Yes

Power

Output voltage @ 2 Ohm.....4x 72W
Output voltage @ 4 Ohm.....4x 45W
Operation voltage.....9.6V - 14.4V DC
Max current draw.....7A
Standby current draw.....6mA

Multi-Environment Certifications

Waterproof / Dustproof.....Yes IP65 (Remote Control rated IP66)
Conformal PCB coating.....Yes
UV protection.....500 hours stable, ASTM D4329 compliant
Salt/Fog protection.....500 hours stable, ASTM B117 compliant
Stainless Steel mountings.....Yes

6.2 Dimensions

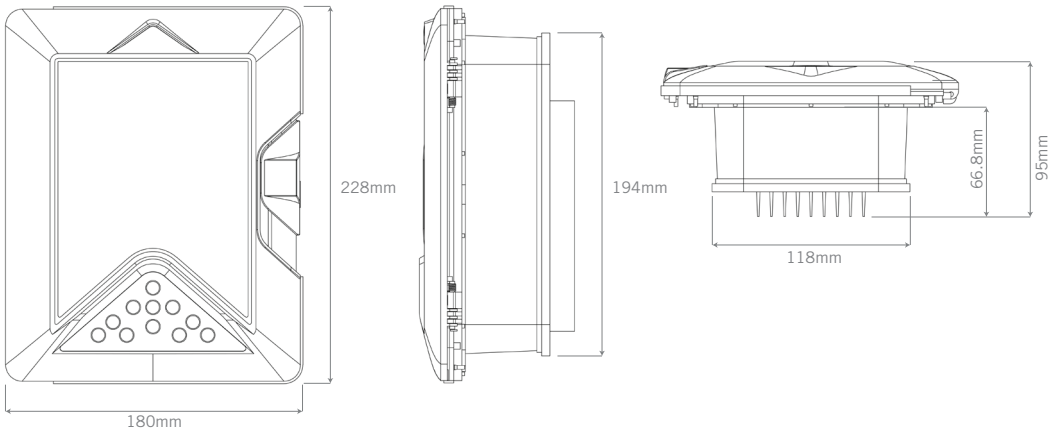

Aquatic AV offers a limited warranty of our products on the following terms:

Length of warranty

2 years on audio systems, electronics, speakers, and accessories (receipt required).

Coverage

This warranty covers only the original purchaser of a Aquatic AV product purchased from an authorized Aquatic AV dealer in the United States. In order to receive service, the purchaser must provide Aquatic AV with a copy of the receipt stating the customer name, dealer name, product purchased and date of purchase.

Defective products

Products found to be defective during the warranty period will be repaired or replaced (with a product deemed to be equivalent) at Aquatic AV's discretion.

What is not covered

Damage caused by accident, abuse, improper operations, theft. Any cost or expense related to the removal or reinstallation of product. Service performed by anyone other than an authorized Aquatic AV service center. Any product with the serial number or tamper labels defaced, altered, or removed. Subsequent damage to other components. Any product not purchased from an authorized Aquatic AV dealer.

Limit on implied warranties

Any implied warranties including warranties of fitness for use and merchantability are limited in duration to the period of the express warranty set forth above. Some states do not allow limitations on the length of an implied warranty, so this limitation may not apply. No person is authorized to assume for Aquatic AV any other liability in connection with the sale of the product.

How to obtain service

You must obtain a return material authorization number (RMA) to return any product to Aquatic AV. You are responsible for shipping charges of returned products to Aquatic AV.

Please record the model and serial number[s] of your equipment in the space provided below as your permanent record and will assist us with your factory warranty coverage. These numbers can be found on the rear of the Digital Media Locker.

| Model number[s]: | Serial number[s]: |
|------------------|-------------------|
| | |
| | |
| | |

FCC ID:
MADE IN CHINA

This device complies with Part 15 of the FCC Rules. Operation is subject to the following two conditions: (1) this device may not cause harmful interference, and (2) this device must accept any interference received, including interference that may cause undesired operation.

NOTE:

The equipment has been tested and found to comply with the limits for a Class B digital device, pursuant to Part 15 of the FCC Rules. These limits are designed to provide reasonable protection against harmful interference in a residential installation. This equipment generates, uses and can radiate radio frequency energy and, if not installed and used in accordance with the instructions, may cause harmful interference to radio communications. However, there is no guarantee that interference will not occur in a particular installation.

If this equipment does cause harmful interference to radio or television reception, which can be determined by turning the equipment off and on, the user is encouraged to try to correct the interference by one or more of the following measures:

- Reorient or relocate the receiving antenna.
- Increase the separation between the equipment and receiver.
- Consult the dealer or an experienced radio/TV technician for help.

The manufacturer is not responsible for any radio or TV interference caused by unauthorized modifications to this equipment. Such modifications could void the user authority to operate the equipment.

Patent: 7,831,756 & 8,578,081

Digital Media Locker is a trademark of Aquatic AV Inc. iPhone, iPod, iPod touch and iPod nano are trademarks of Apple Inc., registered in the U.S. and other countries.

Made for iPod and Made for iPhone mean that an electronic accessory has been designed to connect specifically to iPod or iPhone respectively, and has been certified by the developer to meet Apple performance standards. Apple is not responsible for the operation of this device or its compliance with safety and regulatory standards. Please note that the use of this accessory with iPod or iPhone may affect wireless performance.

Product design and specification subject to change without notice. E&OE.

Doc V1.3



Aquatic AV

282 Kinney Drive
San Jose, CA 95112, USA

E-mail: info@aquaticav.com

US & Canada: 1 877 579 2782

International: +1 408 559 1668

Fax: +1 408 559 0125

www.aquaticav.com



products with a watertight reputation